

SECTION DETAIL @ WALKWAY

1-1/2" = 1' - 0" (A4.2.3)

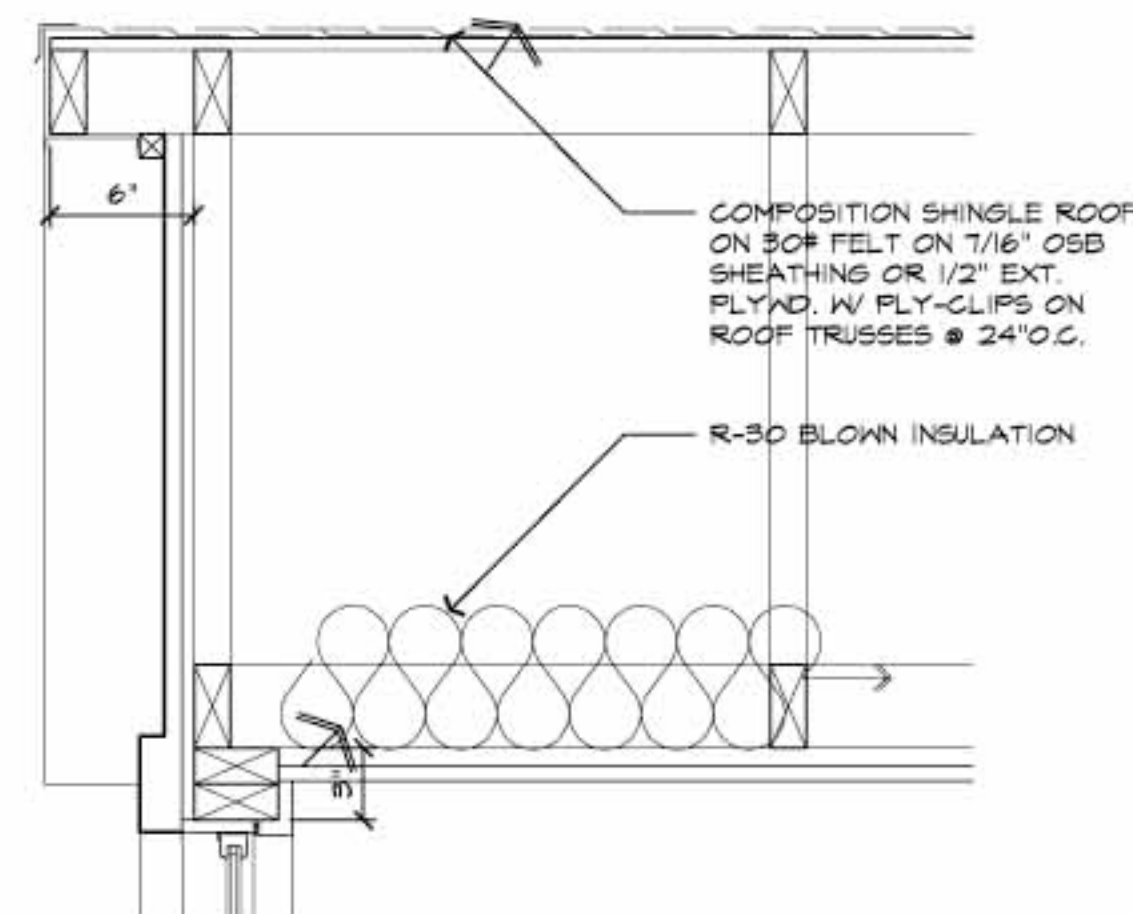

SECTION DETAIL

1-1/2" = 1' - 0" (A4.2.3)

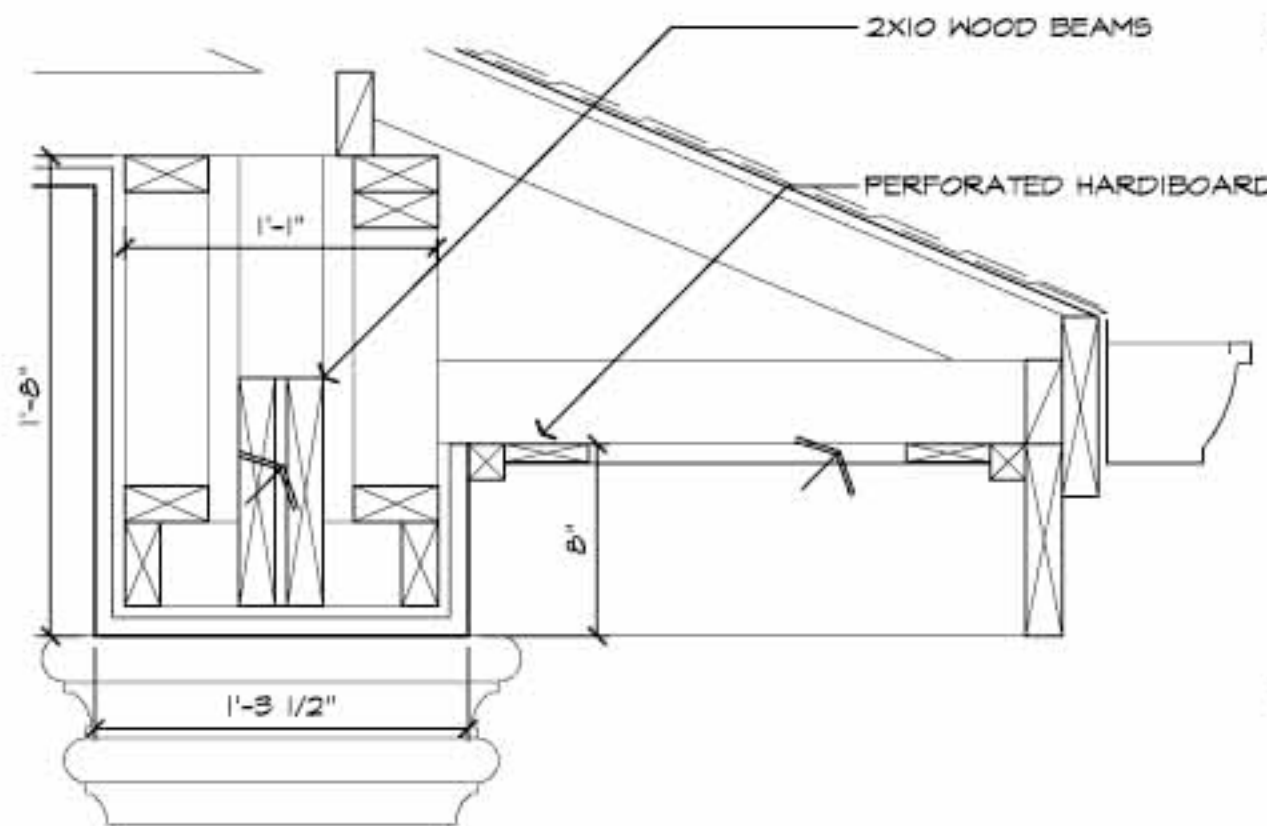

SECTION DETAIL

1-1/2" = 1' - 0" (A4.2.3)

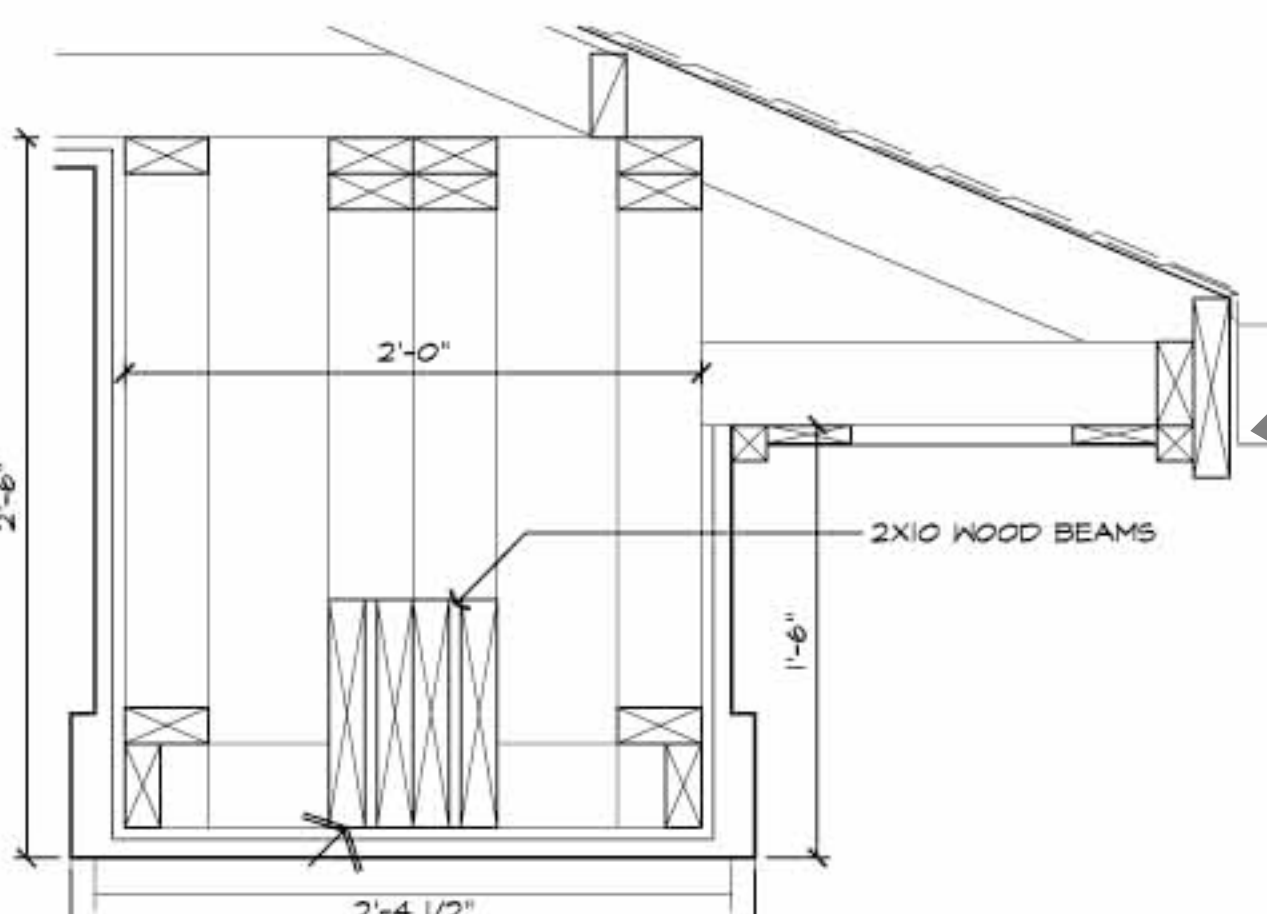

SECTION DETAIL

1-1/2" = 1' - 0" (A4.2.3)

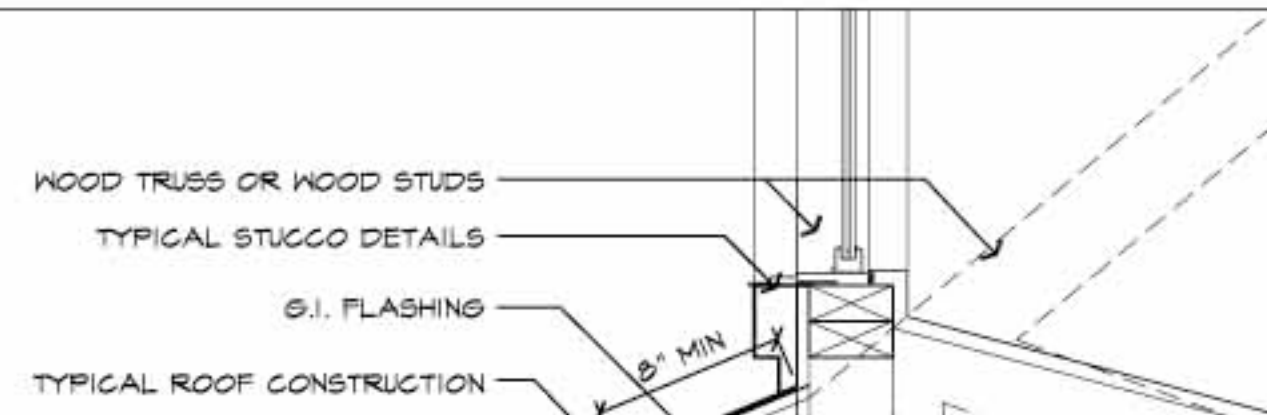

SECTION DETAIL

1-1/2" = 1' - 0" (A4.2.3)

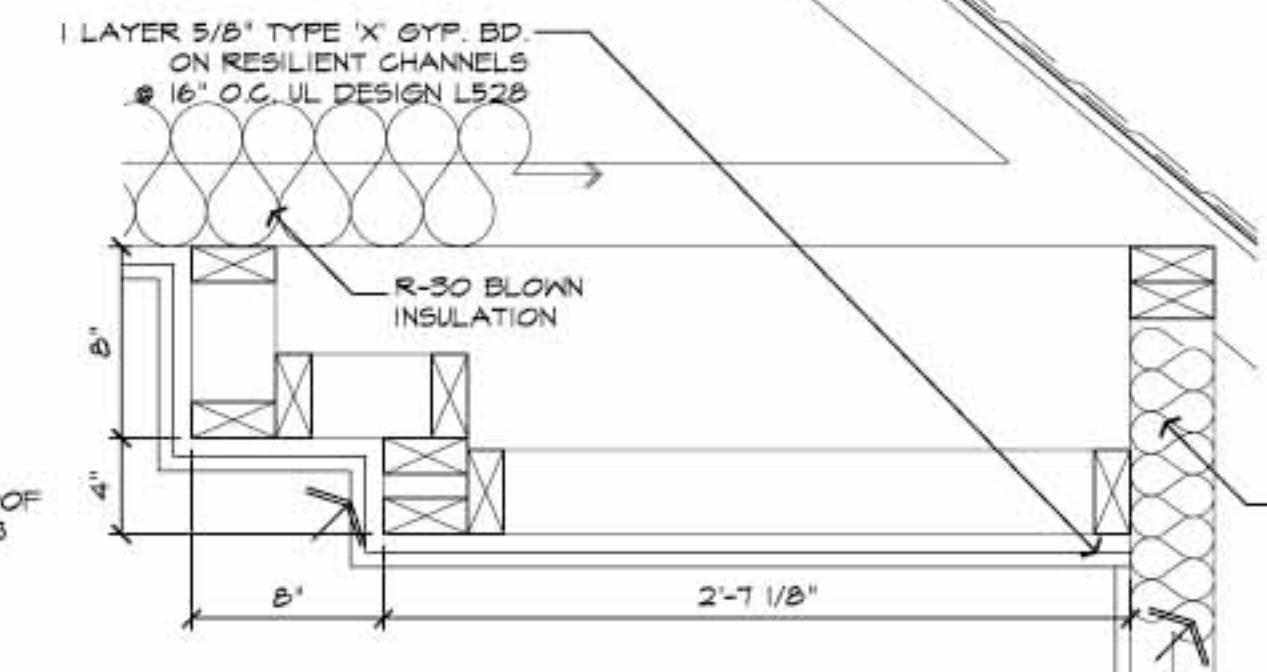

SECTION DETAIL

1-1/2" = 1' - 0" (A4.2.2)

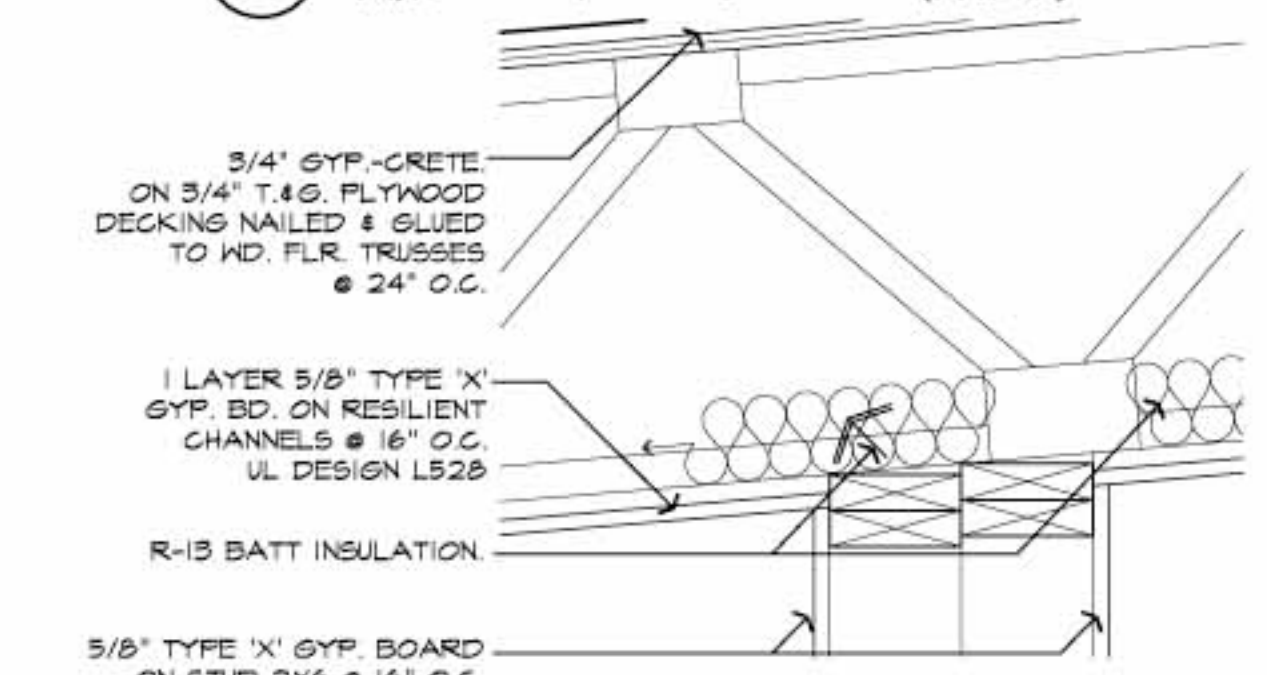

SECTION DETAIL

1-1/2" = 1' - 0" (A4.2.2)

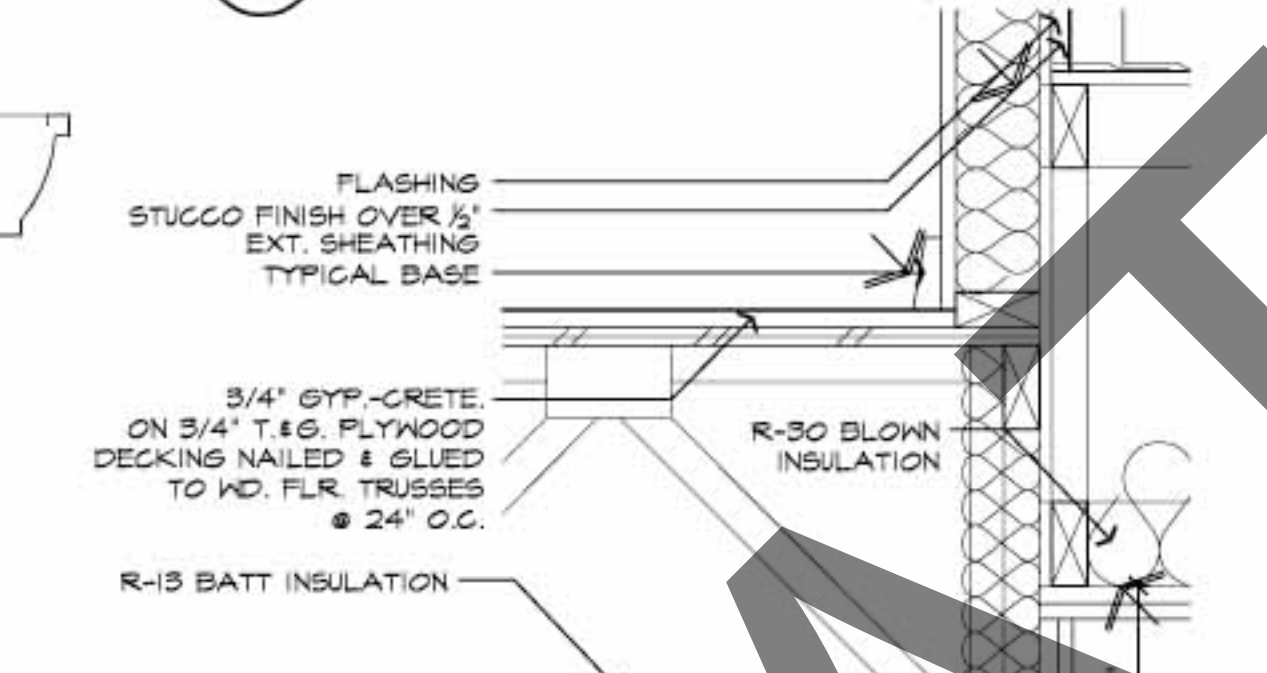

SECTION DETAIL

1-1/2" = 1' - 0" (A4.2.2)

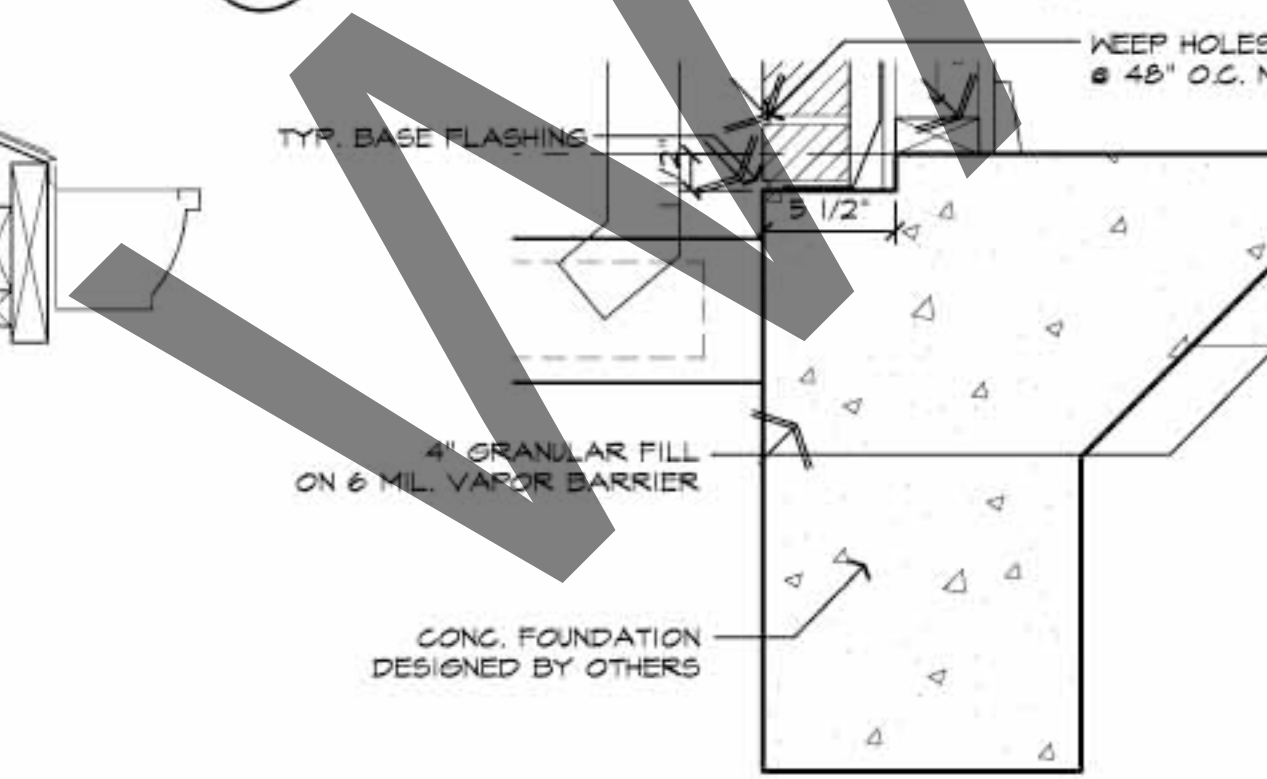

SECTION DETAIL

1-1/2" = 1' - 0" (A4.2.2)

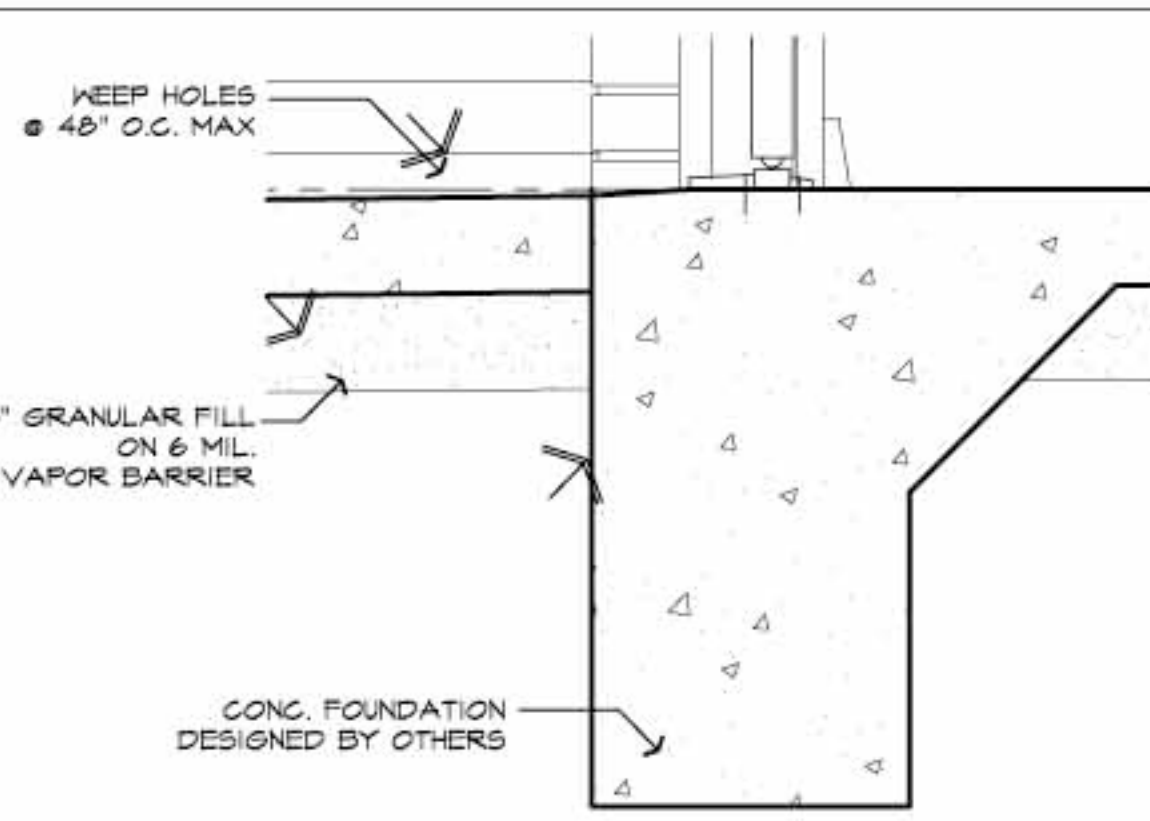

SECTION DETAIL

1-1/2" = 1' - 0" (A4.2.1)

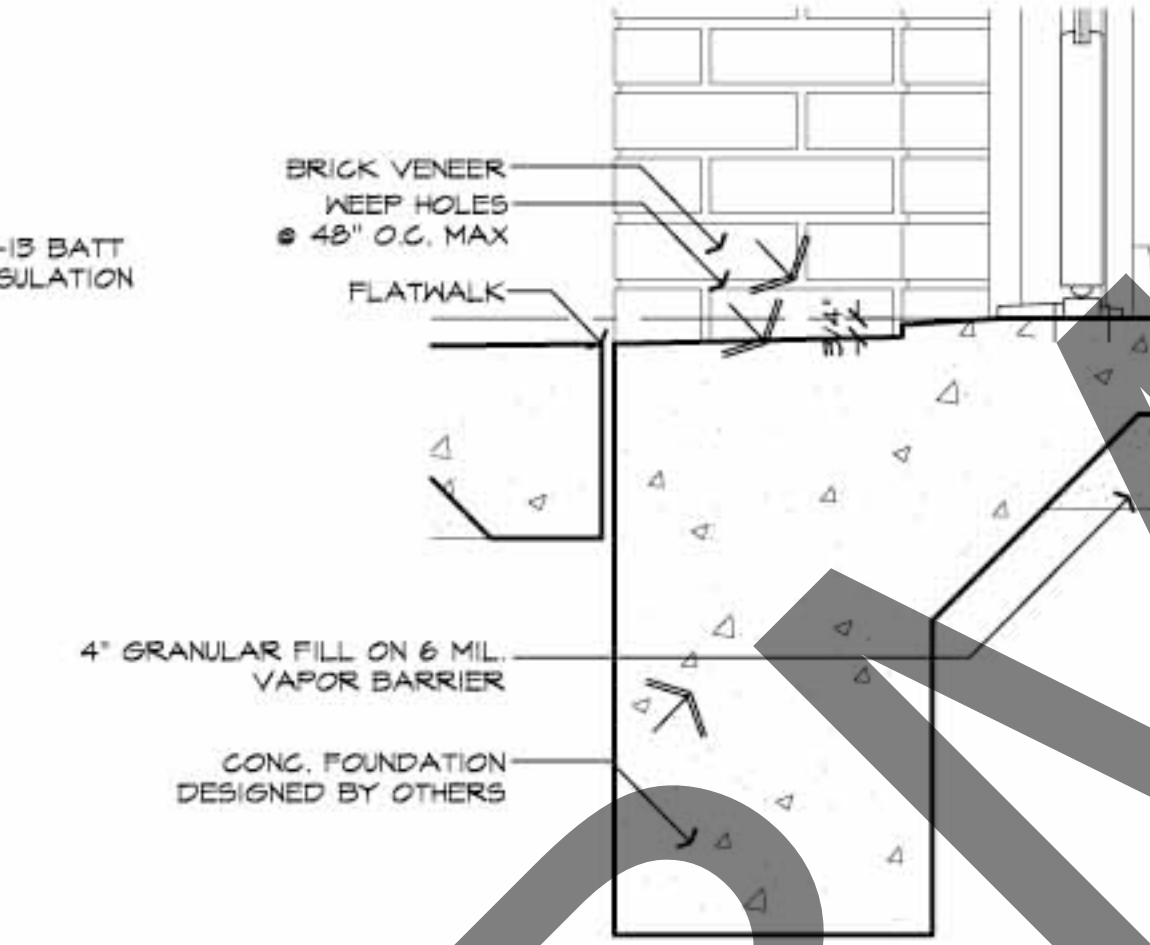

SECTION DETAIL

1-1/2" = 1' - 0" (A4.2.1)

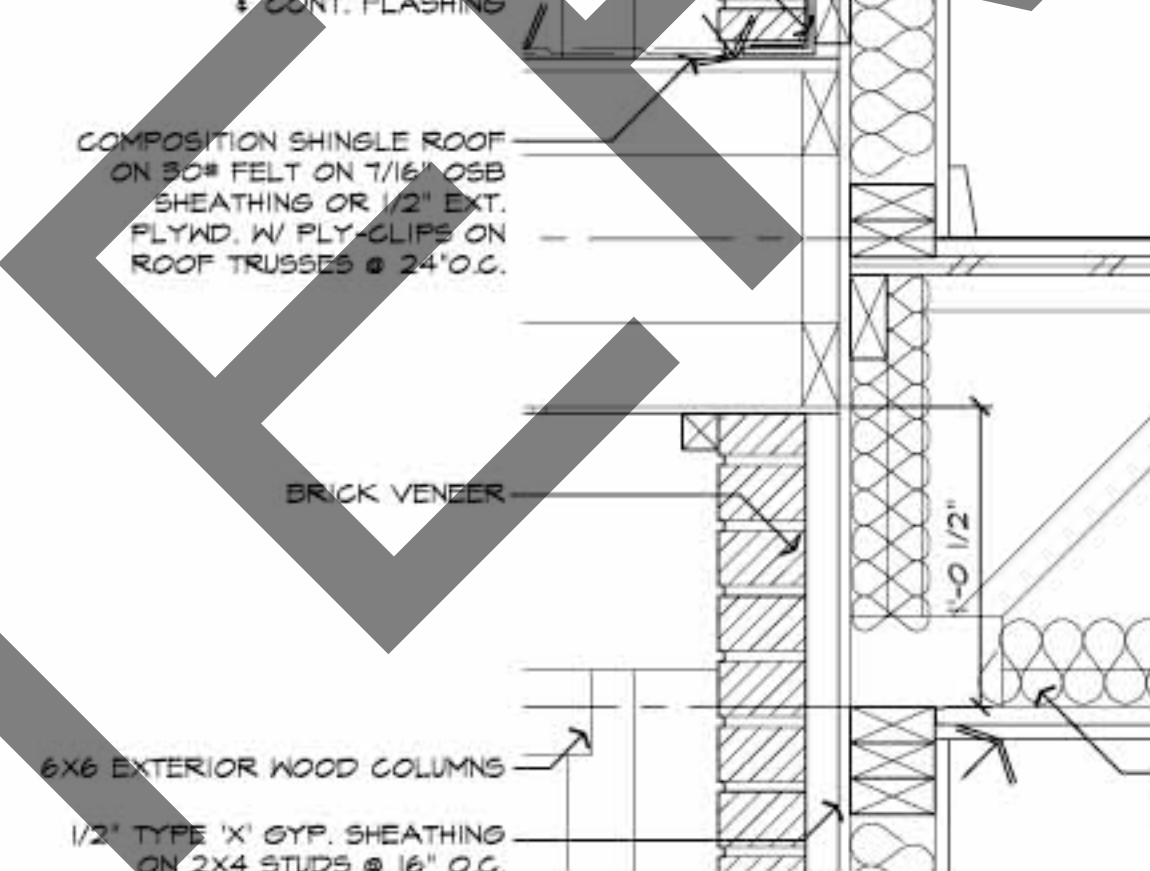

SECTION DETAIL

1-1/2" = 1' - 0" (A4.2.1)

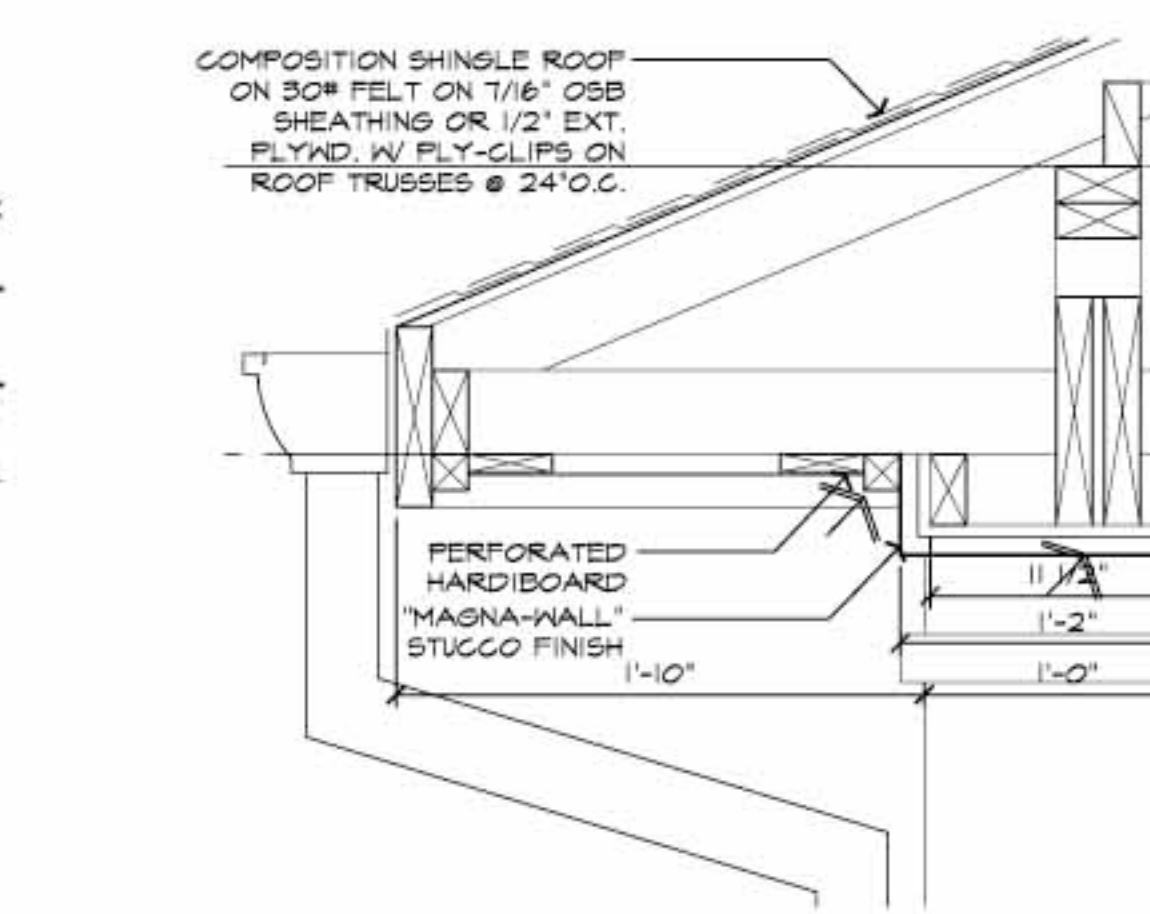

SECTION DETAIL

1-1/2" = 1' - 0" (A4.2.1)

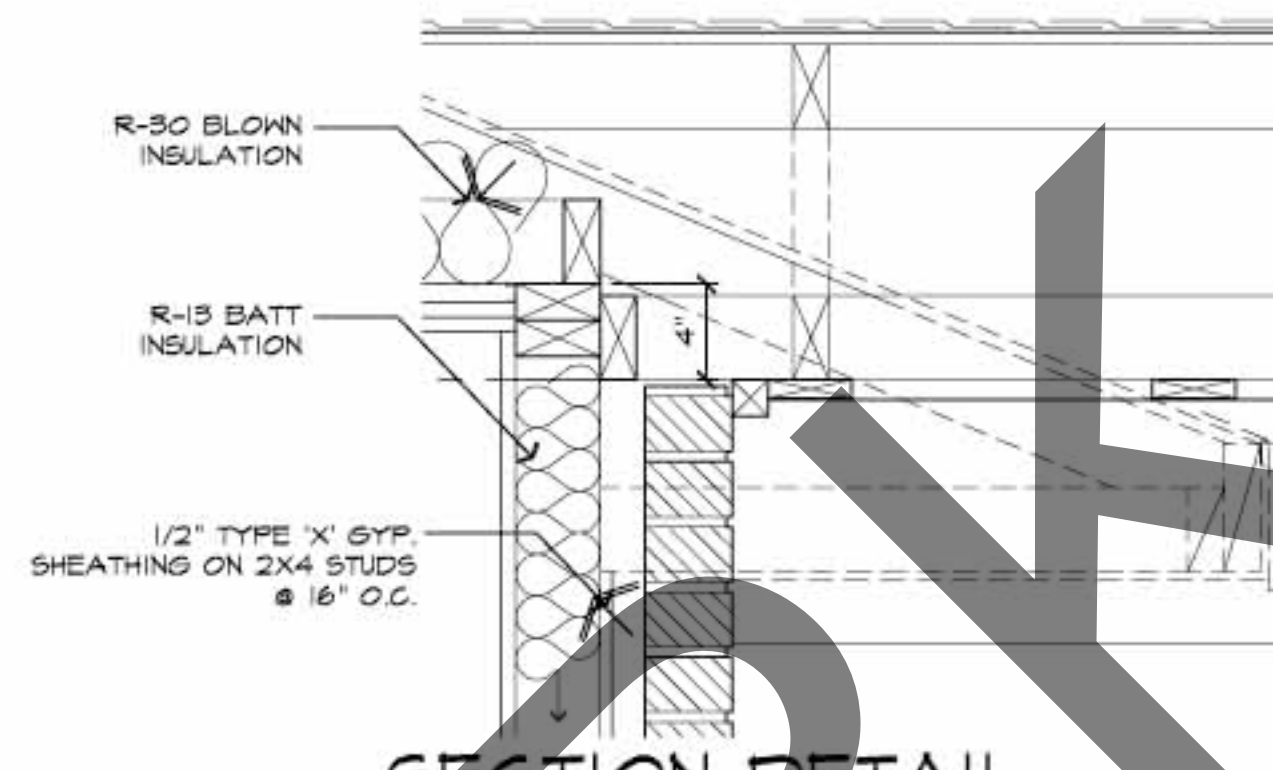

SECTION DETAIL @ WALKWAY

1-1/2" = 1' - 0" (A4.2.1)

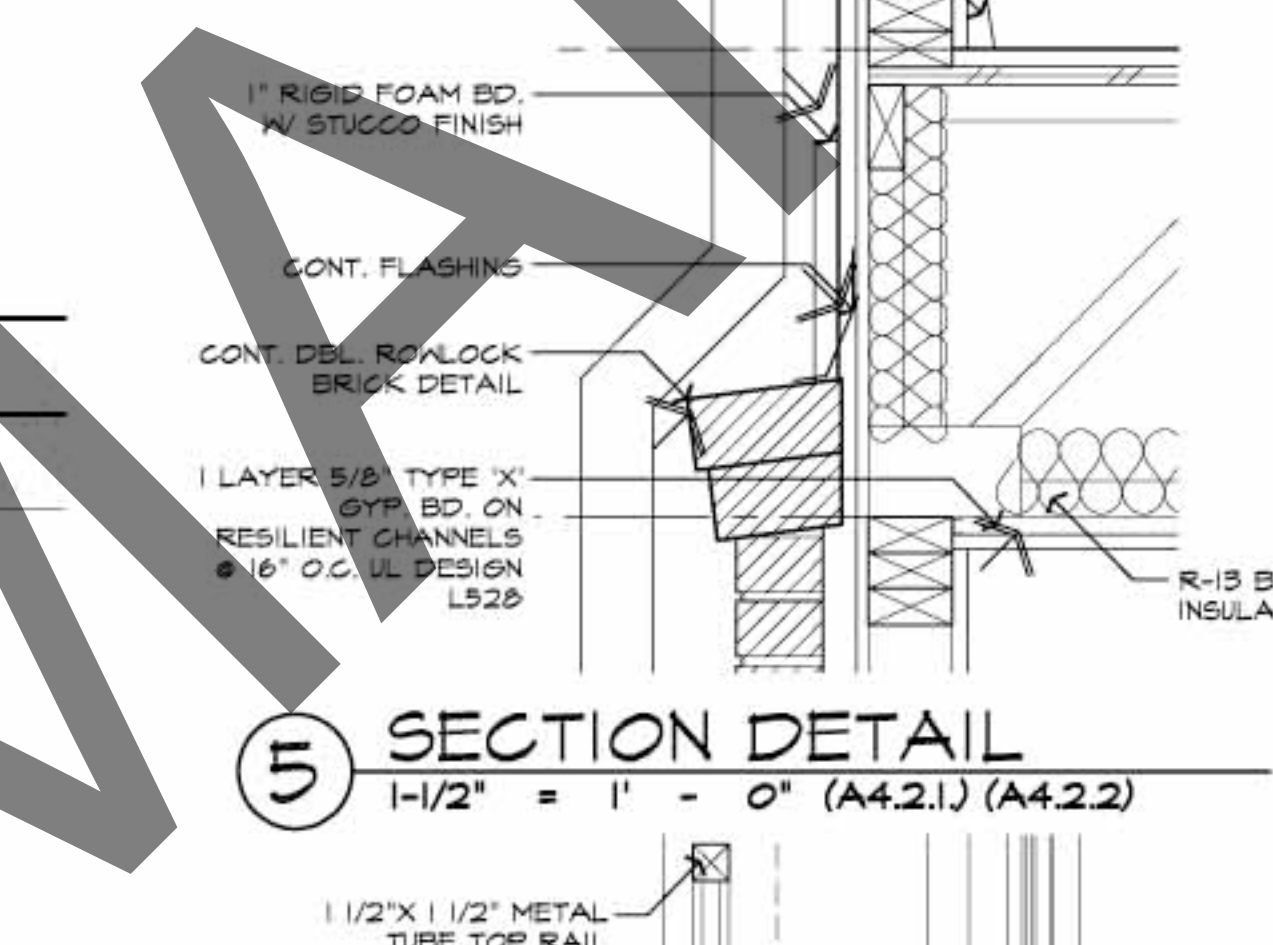

SECTION DETAIL

1-1/2" = 1' - 0" (A4.2.1) (A4.2.2)

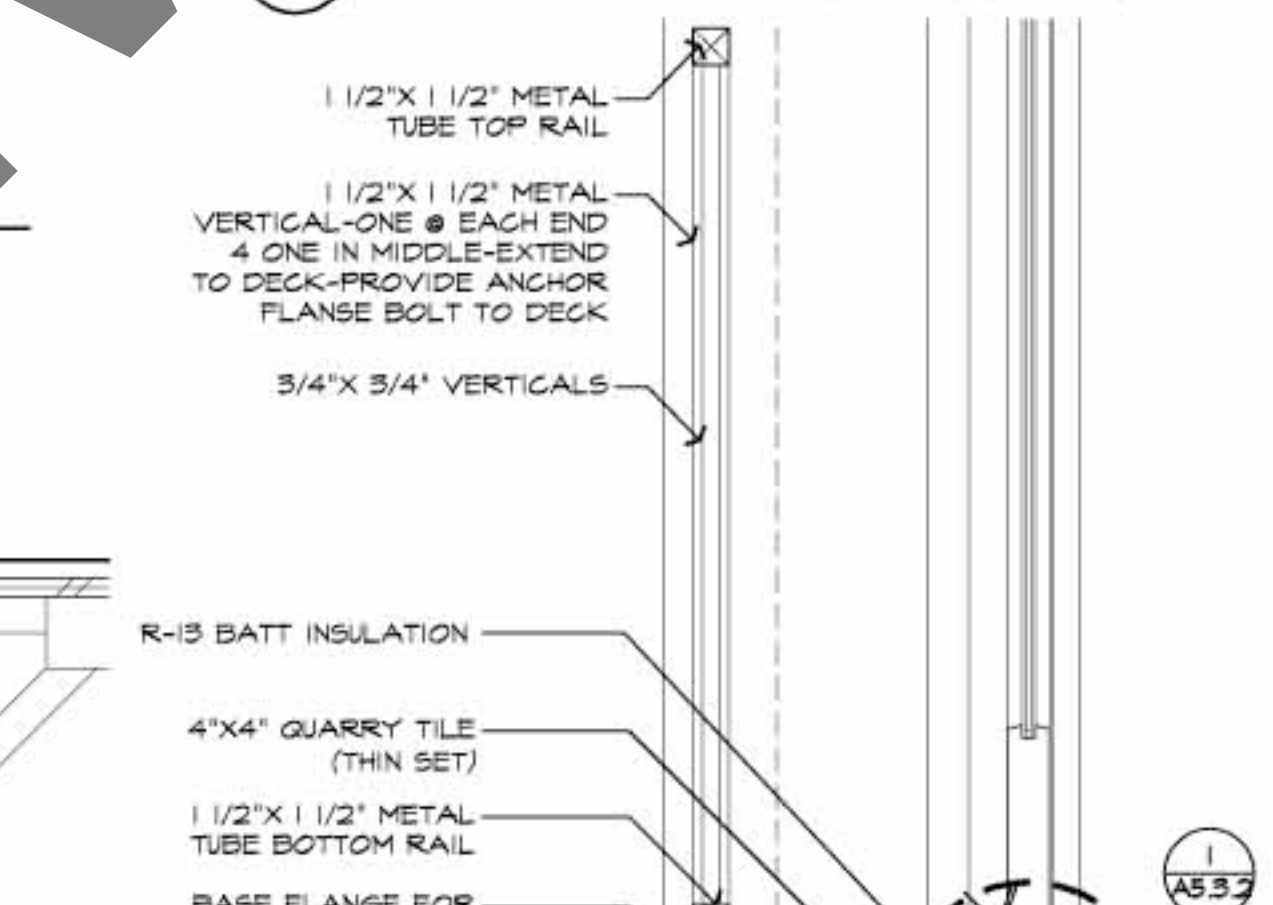

SECTION DETAIL

1-1/2" = 1' - 0" (A4.2.1)

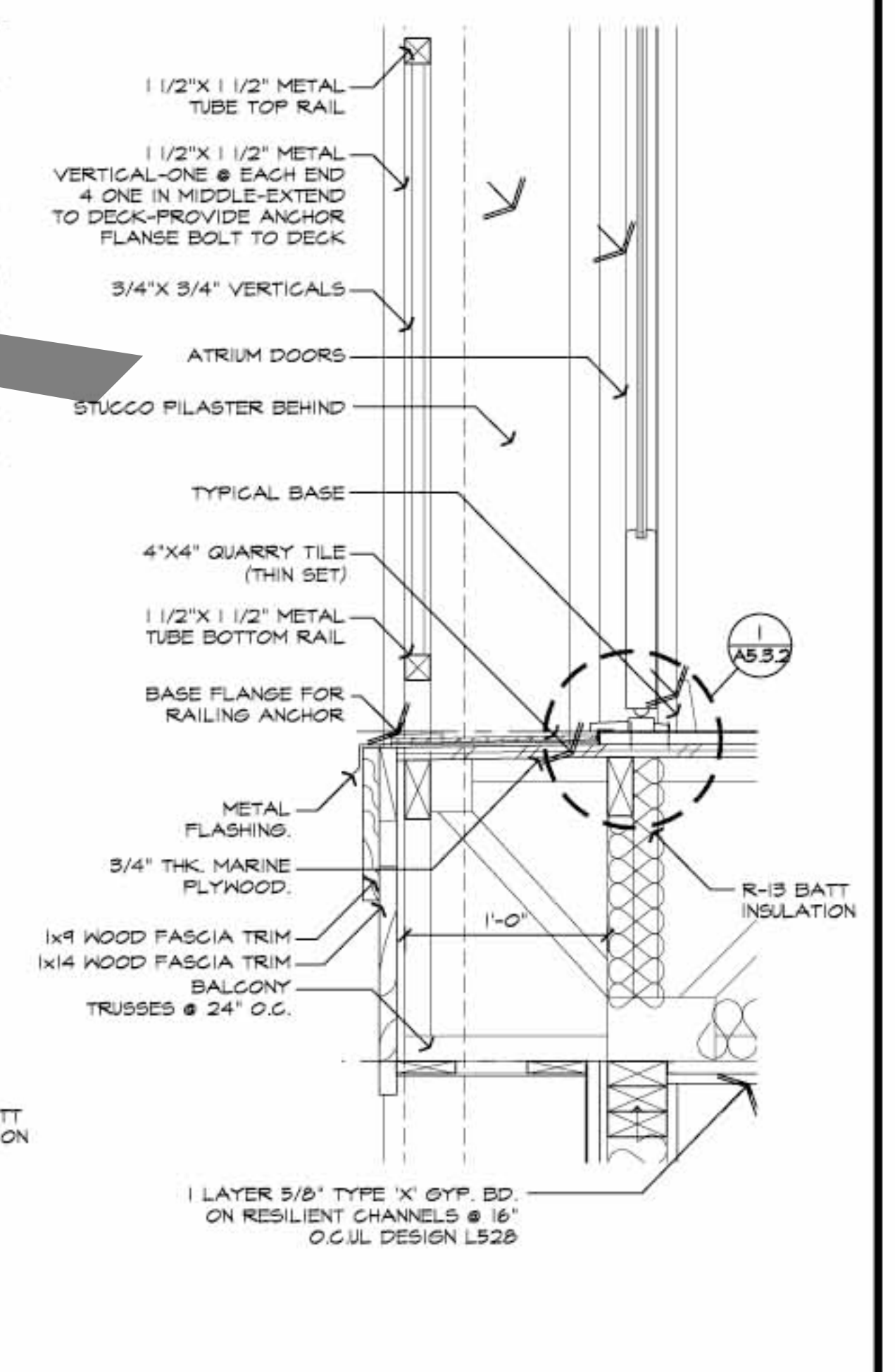

SECTION DETAIL

1-1/2" = 1' - 0" (A4.2.1)

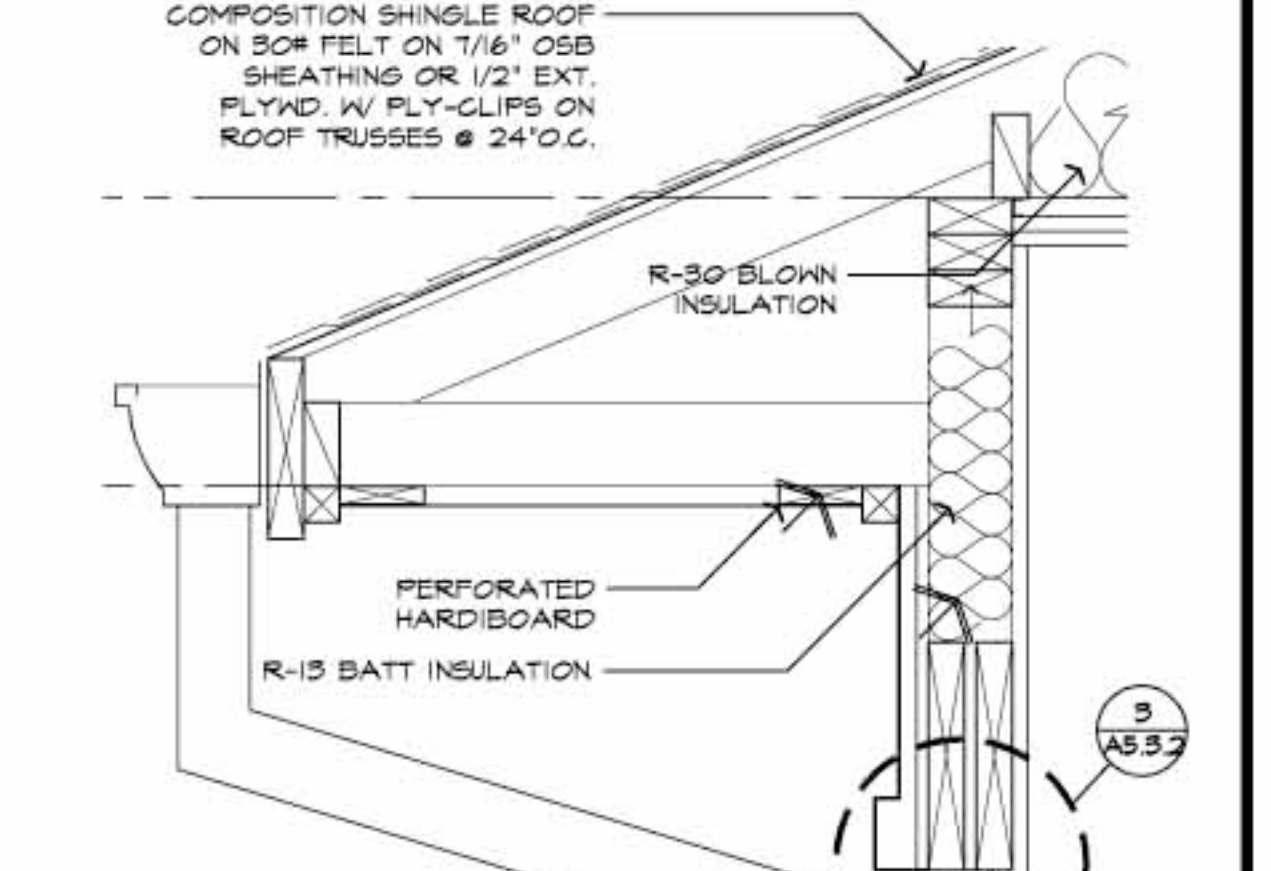

SECTION DETAIL

1-1/2" = 1' - 0" (A4.2.1) (A4.2.2)

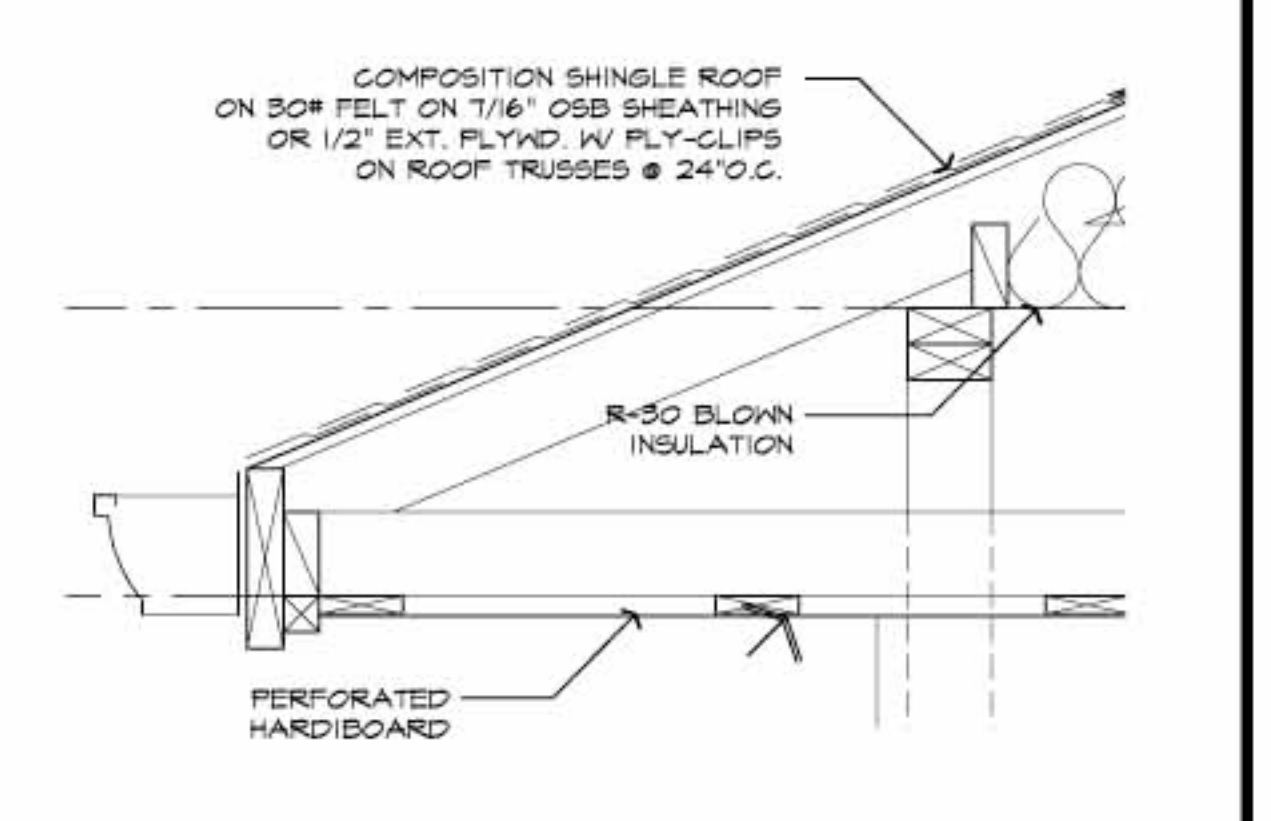

SECTION DETAIL

1-1/2" = 1' - 0" (A4.2.1) (A4.2.3)